

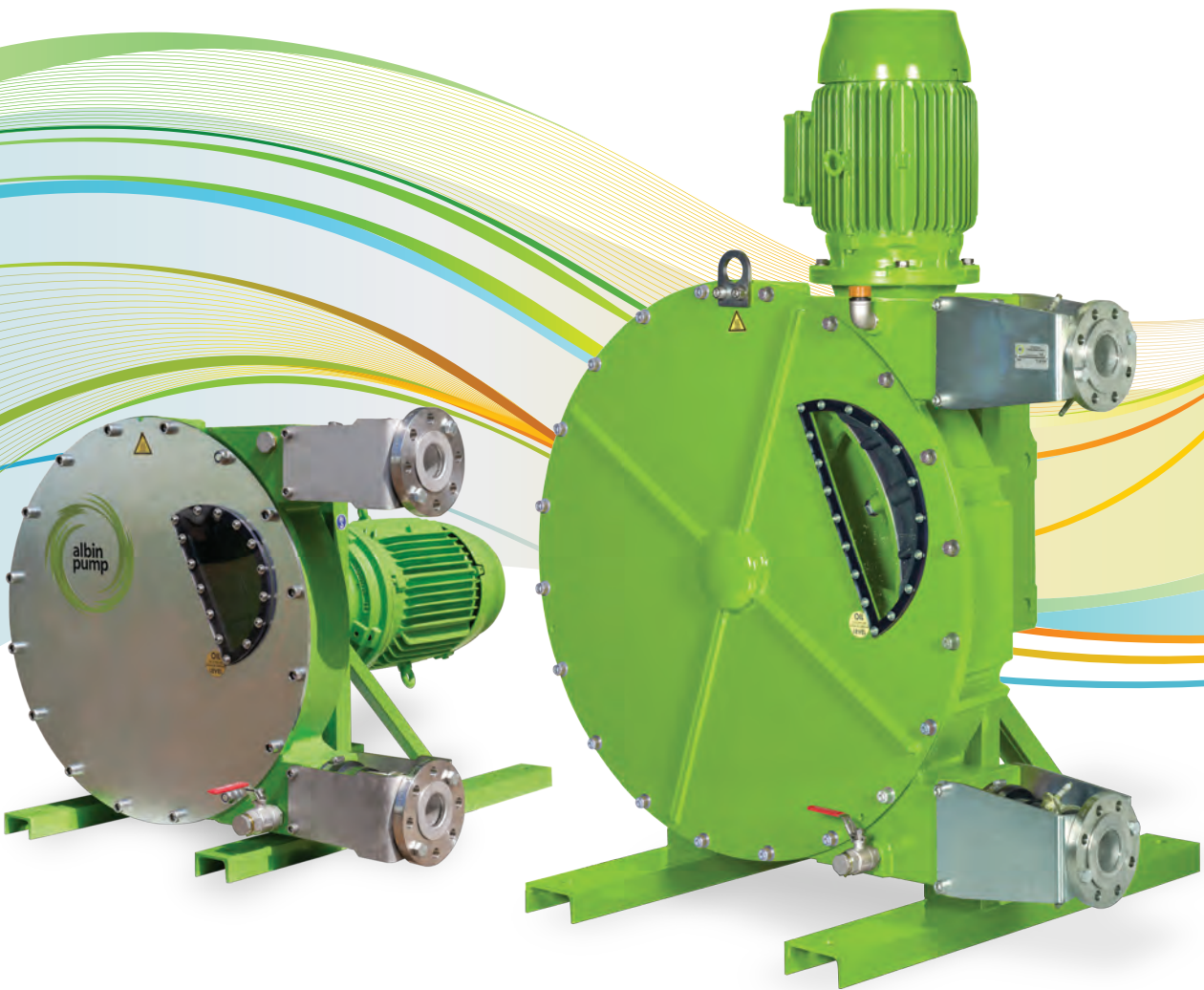

# ALBIN PUMP ALH

*High Pressure Hose Pumps*





# BETTER PERISTALTIC AND HOSE PUMP SOLUTIONS



Albin Pump is the expert in delivering peristaltic pumps that have been engineered with decades of industry experience to provide the performance, design simplicity and reliability our customers demand to achieve the lowest total cost of ownership.

Founded in 1928, Albin Pump is a leading manufacturer of electric peristaltic pumps, and is part of the Fluid sector of Ingersoll Rand including premium brands such as: ARO, Milton Roy, Thomas, Dosatron, Haskel, SEEPEX and more.

## MARKETS AND APPLICATIONS



**Water/Wastewater** – Lime water, granular activated carbon (GAC), sodium hypochlorite, ferric chloride, sodium bisulfite, fluoride, polymers, aqueous ammonia, potassium, permanganate, caustic soda, and many more



**Mining/Quarries** – Sludge, viscous fluids, mud, clay, fluids with high solid content, light concrete, lead sulfate, pyrite, SABX, cyanide, various acids



**Chemical** – Corrosive acids and bases, latex, alcohol, soap, shampoo, cleaning agents, non aromatic solvents, chemical dosing, paint, water based paint, acrylics, pigments, ink, wall coating



**Food and Beverage** – Yeast, diatomaceous earth, egg white and yolk, fats, olive oil, wine, semolina, water and salt mixtures, natural flavorings, bakery dough/batter, cream, sugar mills, molasses, liquid sugar, liquid protein, syrups



**General and Other Industries** – Kaolin, pulp and paper waste sludge, manure, fertilizer, ceramic glaze, mold filling, titanium dioxide filter press feeding, building fibrous mortar, plaster, liquid cement



## PUMP BENEFITS

- ✓ Best total cost of ownership
- ✓ High quality with a longer hose life
- ✓ Faster and easier maintenance
- ✓ Better service
- ✓ Competitive lead time
- ✓ Low shear
- ✓ Predictable performance with subsequent cost savings
- ✓ Available in many different sizes for flow rates up to 120m<sup>3</sup>/h (528 gpm) (ALH125 Duplex)
- ✓ Unparalleled Versatility – two hose sizes available for a common pump.



## PUMP FEATURES

- ✓ Fully self-priming
- ✓ Damage-free continuous dry running
- ✓ No mechanical seal nor packing gland
- ✓ Suitable for abrasive, corrosive or viscous fluids
- ✓ Easy installation, operation and maintenance
- ✓ Reversible flow
- ✓ Low sound level
- ✓ Perfect volumetric flow
- ✓ Accurate and repeatable dosing and metering
- ✓ Long life and greater reliability
- ✓ Lowest cost of ownership
- ✓ Stainless steel hardware



## HOSE FEATURES AND BENEFITS

- ✓ Highest quality compound rubber
- ✓ Long life material and structure with inner reinforcement layers
- ✓ Suitable for pressure up to 15 bar (220 psi)
- ✓ Available in 7 different rubber compounds and in 16 different sizes to fit most competitor pumps

## OUR PERISTALTIC PUMP RANGE

PUMP MODEL	MAX FLOW	RECOMMENDED FLOW RANGE	MAX PRESSURE	PUMP WEIGHT	PUMP CONNECTION
<b>ALH / High Pressure Hose Pump</b>					
ALH05-3	20,4 l/h (5 gph)	4,1 - 14,3 l/h (1-4 gph)	8 bar (115 psi)	25 kg (55 lb)	Hose tail Ø 16mm (5/8 in)
ALH10-3	70 l/h (18 gph)	12 - 42 l/h (3-11 gph)	10 bar (145 psi)	28 kg (62 lb)	Hose tail Ø 16 mm (5/8 in)
ALH10	180 l/h (48 gph)	18 - 90 l/h (5-24 gph)	10 bar (145 psi)	25 kg (55 lb)	Hose tail Ø 16 mm (5/8 in)
ALH15-3	420 l/h (111 gph)	42 - 147 l/h (11-39 gph)	10 bar (145 psi)	35 kg (77 lb)	Hose tail Ø 20 mm (7/8 in)
ALH15	600 l/h (159 gph)	60 - 315 l/h (16-83 gph)	10 bar (145 psi)	35 kg (77 lb)	Hose tail Ø 20 mm (7/8 in)
ALH20-3	670 l/h (177 gph)	71 - 291 l/h (19-77 gph)	10 bar (145 psi)	36 kg (79 lb)	Hose tail Ø 25 mm (1 in)
ALH20	1020 l/h (269 gph)	102 - 535 l/h (27-141 gph)	10 bar (145 psi)	36 kg (79 lb)	Hose tail Ø 25 mm (1 in)
ALH25	2,2 m³/h (10 gpm)	0,3 - 1 m³/h (1.4-4.3 gpm)	15 bar (220 psi)	80 kg (176 lb)	Flange DN25/PN16 (1 in/150#)
ALH32	5,3 m³/h (23 gpm)	0,8 - 2,3 m³/h (3.3-10 gpm)	15 bar (220 psi)	145 kg (320 lb)	Flange DN32/PN16 (1.25 in/150#)
ALH40	8,2 m³/h (36 gpm)	1,3 - 3,6 m³/h (5.2-15.7 gpm)	15 bar (220 psi)	145 kg (320 lb)	Flange DN40/PN16 (1.5 in/150#)
ALHX40	9,6 m³/h (42 gpm)	2 - 5 m³/h (8.8-22 gpm)	15 bar (220 psi)	210 kg (463 lb)	Flange DN40/PN16 (1.5 in/150#)
ALH50	15,8 m³/h (70 gpm)	3,5 - 10,3 m³/h (15-45 gpm)	15 bar (220 psi)	315 kg (694 lb)	Flange DN50/PN16 (2 in/150#)
ALH65	20,7 m³/h (91 gpm)	4,6 - 13,6 m³/h (20-60 gpm)	15 bar (220 psi)	335 kg (739 lb)	Flange DN65/PN16 (2.5 in/150#)
ALHX65	22 m³/h (96.9 gpm)	8,3 - 16,7 m³/h (36.5-73.5 gpm)	15 bar (220 psi)	500 kg (1102 lb)	Flange DN65/PN16 (2.5 in/150#)
ALHX80	27,5 m³/h (121 gpm)	10,4 - 20,9 m³/h (46-92 gpm)	15 bar (220 psi)	700 kg (1543 lb)	Flange DN80/PN16 (3 in/150#)
ALH80	35 m³/h (154 gpm)	13,3 - 18,9 m³/h (59-83 gpm)	15 bar (220 psi)	970 kg (2138 lb)	Flange DN80/PN16 (3 in/150#)
ALH100	54 m³/h (238 gpm)	21,6 - 37,2 m³/h (95-164 gpm)	15 bar (220 psi)	1270 kg (2800 lb)	Flange DN100/PN16 (4 in/150#)
ALH125	88 m³/h (387 gpm)	44 - 83 m³/h (194-365 gpm)	15 bar (220 psi)	1800 kg (3968 lb)	Flange DN125/PN16 (5 in/150#)

\*contact your sales representative to check connections available on your desired pump size

## EXAMPLE OF AVAILABLE OPTIONS

Duplex pump (dual pumps), special connection such as SMS, Tri-clamp, DIN, ANSI, JIS, thread NPT and BSP\* ... Hose rupture detector and revolution counter, ATEX II & I execution, variable speed drive, mobile trolley and more.

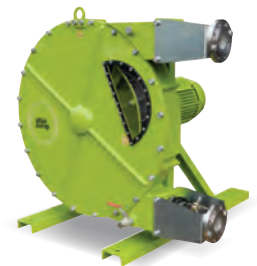

## PUMP OPERATION

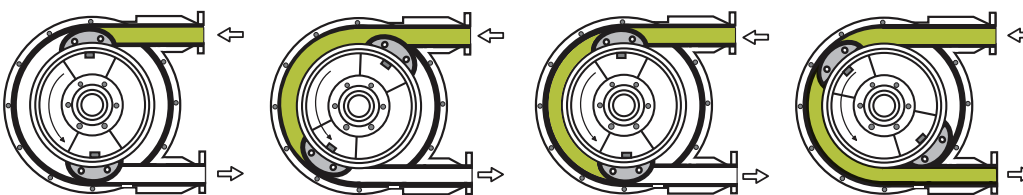

## APPLICATIONS



ALH125 crude oil pumping



ALH65 wastewater treatment



ALHX80 for filter press feeding



ALH65 for chemical dosing

# ALBIN PUMP ALH FLOW CURVES

## HOW TO READ THE PUMP CURVES?

### DETERMINE INSTALLED MOTOR POWER

- 1 - Select the required flow. This gives you the required pump speed.
- 2 - Move upwards to the calculated discharge pressure.
- 3 - Move to the left for the installed motor power.

### VERIFY CURVE ADJUSTMENT FOR TEMPERATURE ABOVE 40°C (104°F)

- 4 - Determine the fluid's max. temperature.
- 5 - Move to the left to the calculated discharge pressure.
- 6 - Move downwards to determine your maximum allowed pump speed for the fluids temperature.

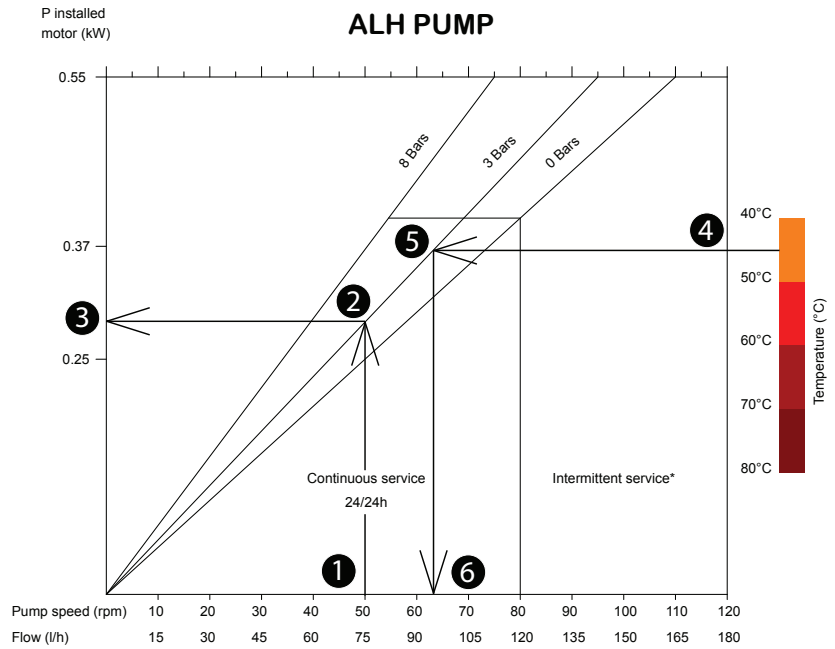

## ALH05 – 3 Lobes

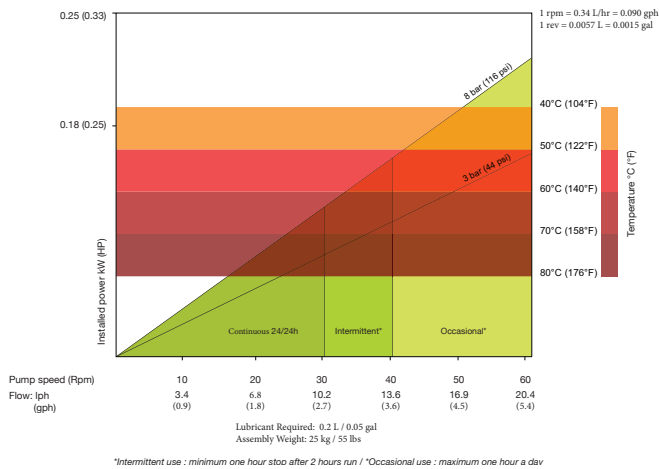

## ALH10 – 3 Lobes

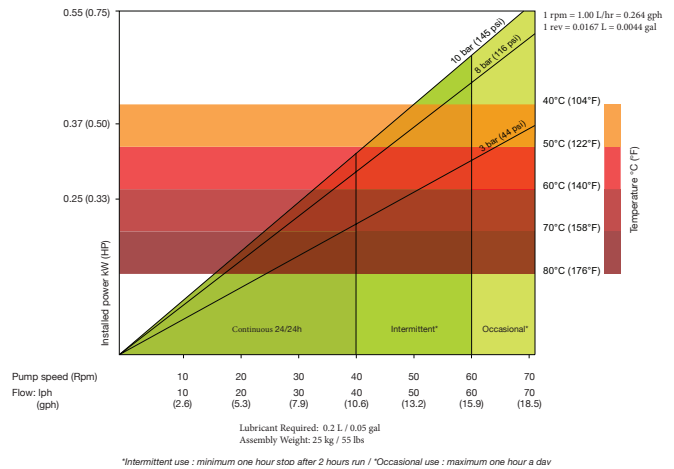

## ALH10

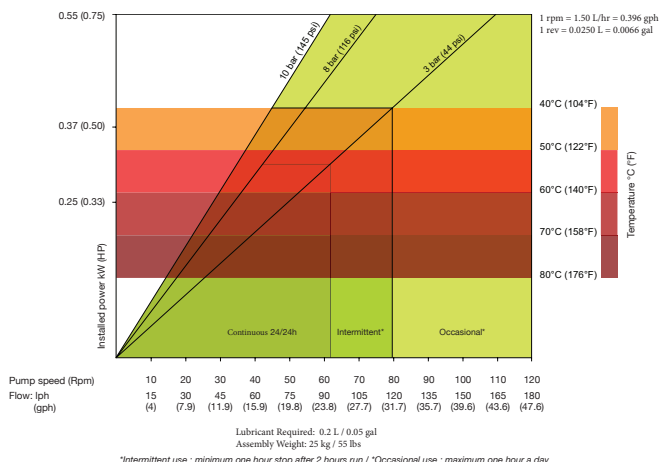

## ALH15 – 3 Lobes

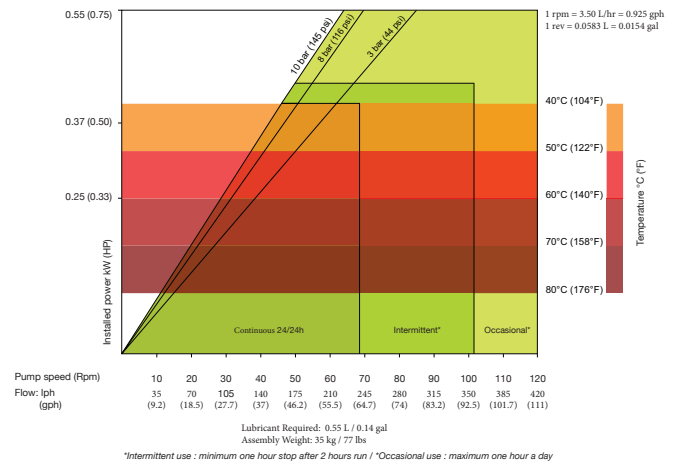

## ALH15

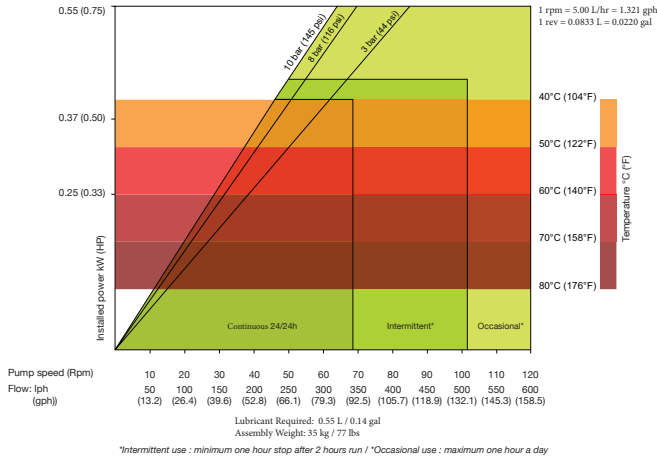

## ALH20 – 3 Lobes

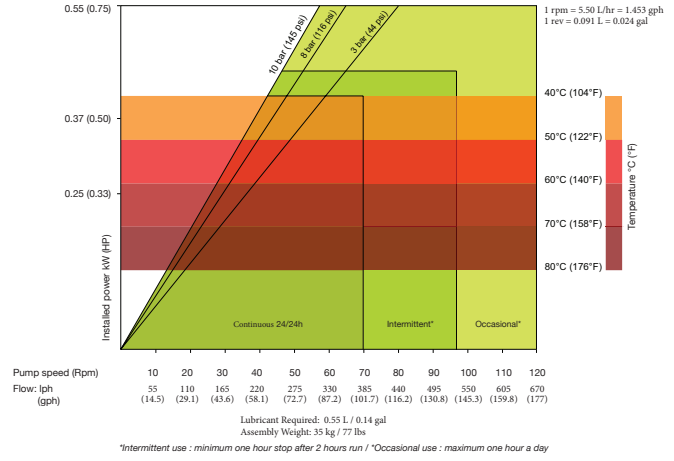

## ALH20

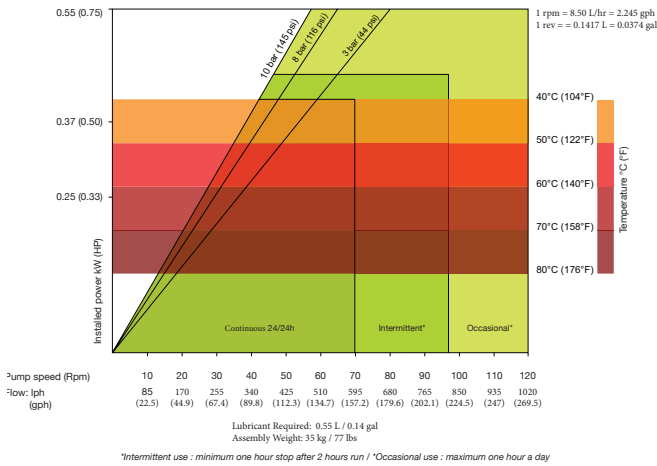

## ALH25

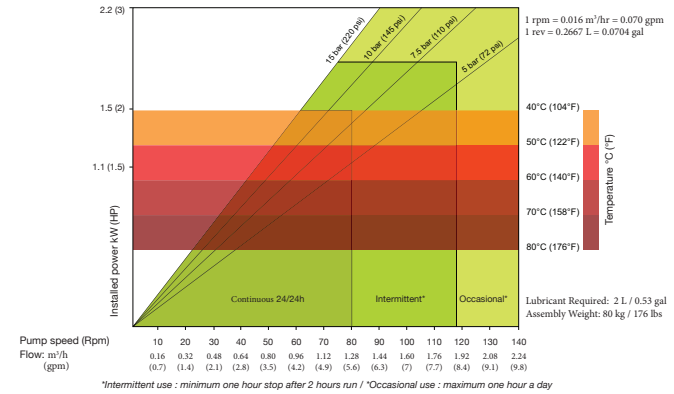

## ALH32

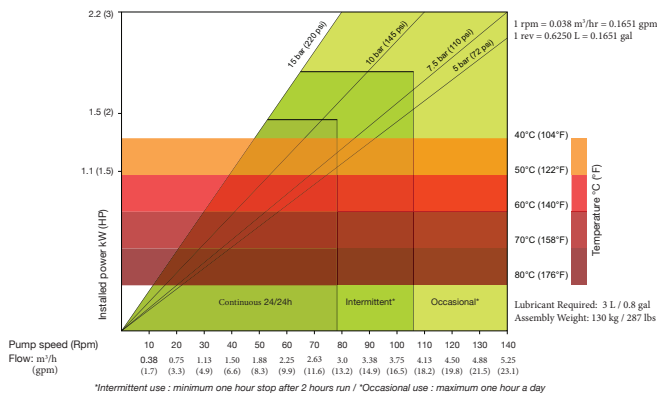

## ALH40

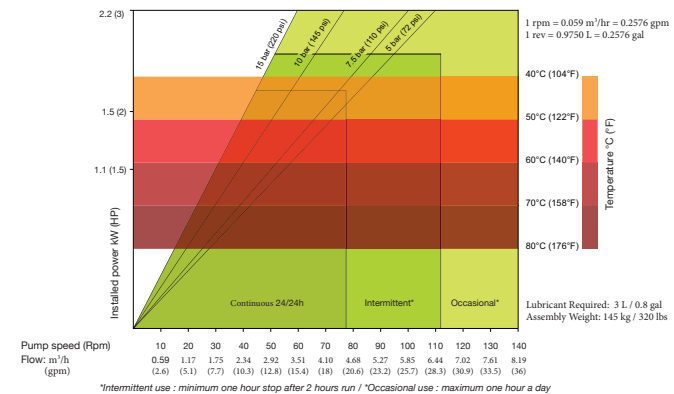



## ALHX40

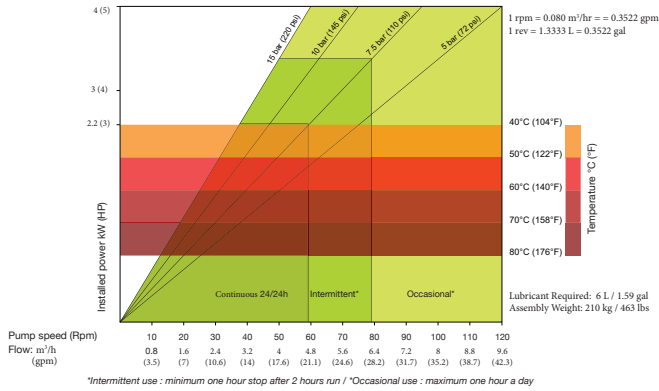

## ALH50

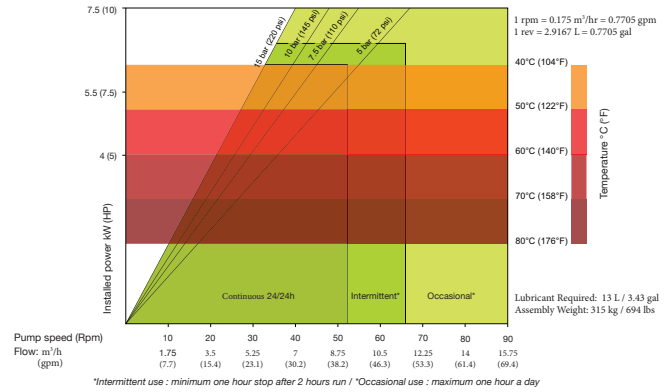

## ALH65

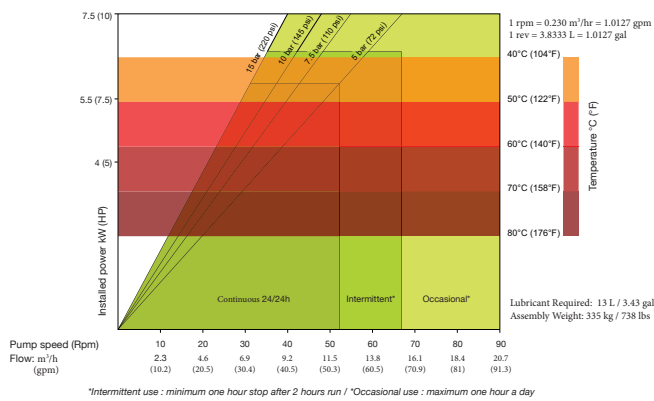

## ALHX65

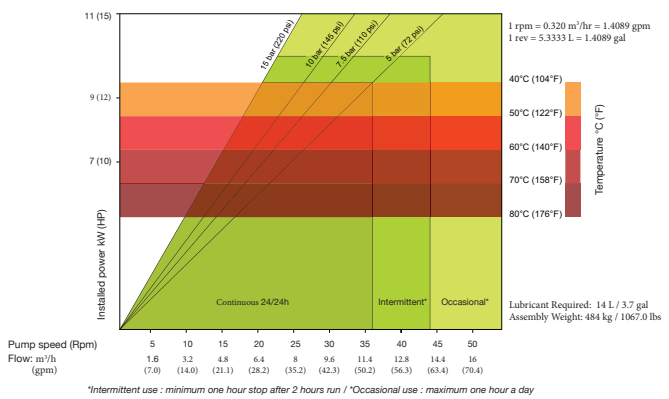

## ALHX80

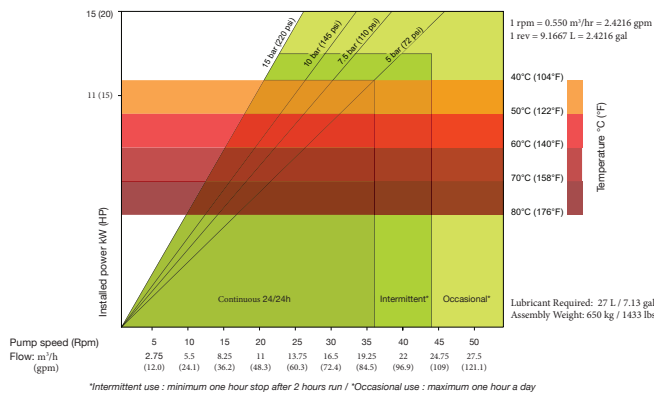

## ALH80

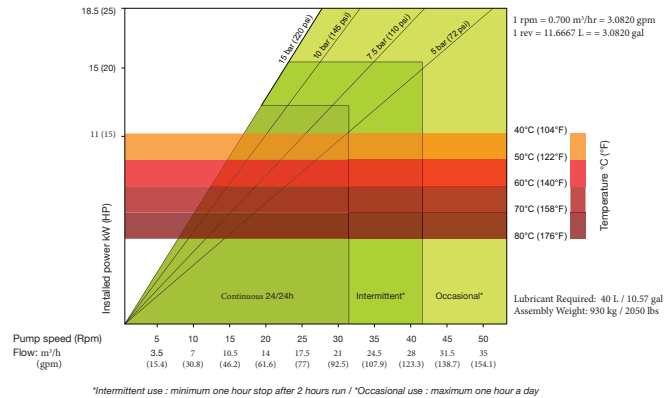

## ALH100

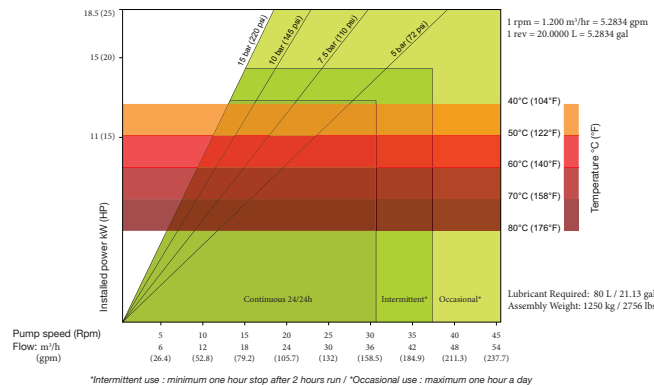

## ALH125

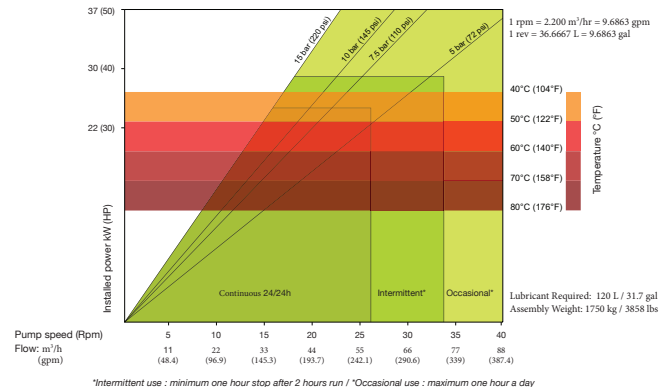

# ALBIN PUMP ALH DIMENSIONS mm (inch)

## ALH05 - 20

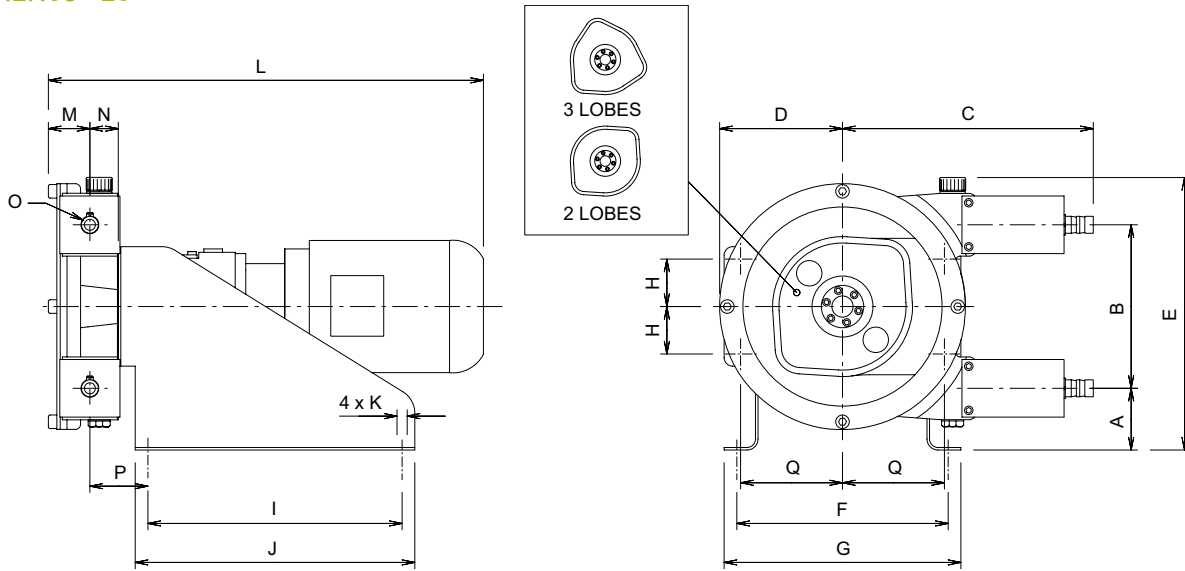

TYPE	A	B	C	D	E	F	G	H	I	J	K	L	M	N	ØO	P	Q
ALH05	104 (4.0)	115 (4.5)	226 (8.9)	95 (3.7)	271 (10.7)	220 (8.7)	240 (9.4)	33.5 (1.3)	260 (10.2)	280 (11.0)	4xø9 (4xø0.35)	-	42.5 (1.7)	36.5 (1.4)	16* (0.6)	66 (2.6)	81.3 (3.2)
ALH10 - 3 Lobes	104 (4.0)	115 (4.5)	226 (8.9)	95 (3.7)	271 (10.7)	220 (8.7)	240 (9.4)	33.5 (1.3)	260 (10.2)	280 (11.0)	4xø9 (4xø0.35)	-	42.5 (1.7)	36.5 (1.4)	16* (0.6)	66 (2.6)	81.3 (3.2)
ALH10	104 (4.0)	115 (4.5)	226 (8.9)	95 (3.7)	271 (10.7)	220 (8.7)	240 (9.4)	33.5 (1.3)	260 (10.2)	280 (11.0)	4xø9 (4xø0.35)	-	42.5 (1.7)	36.5 (1.4)	16* (0.6)	66 (2.6)	81.3 (3.2)
ALH15 - 3 Lobes	73 (2.9)	193 (7.6)	297 (11.7)	145 (5.7)	325 (12.8)	249 (9.8)	280 (11.0)	52 (2.0)	300 (11.8)	330 (13.0)	4xø13 (4xø0.5)	-	46 (1.8)	35.5 (1.4)	20* (0.7)	0.5 (2.8)	124.8 (4.9)
ALH15	73 (2.9)	193 (7.6)	297 (11.7)	145 (5.7)	325 (12.8)	249 (9.8)	280 (11.0)	52 (2.0)	300 (11.8)	330 (13.0)	4xø13 (4xø0.5)	-	46 (1.8)	35.5 (1.4)	20* (0.7)	0.5 (2.8)	124.8 (4.9)
ALH20 - 3 Lobes	73 (2.9)	193 (7.6)	297 (11.7)	145 (5.7)	325 (12.8)	249 (9.8)	280 (11.0)	52 (2.0)	300 (11.8)	330 (13.0)	4xø13 (4xø0.5)	-	46 (1.8)	35.5 (1.4)	20* (0.7)	0.5 (2.8)	124.8 (4.9)
ALH20	73 (2.9)	193 (7.6)	297 (11.7)	145 (5.7)	325 (12.8)	249 (9.8)	280 (11.0)	52 (2.0)	300 (11.8)	330 (13.0)	4xø13 (4xø0.5)	-	46 (1.8)	35.5 (1.4)	20* (0.7)	0.5 (2.8)	124.8 (4.9)

# ALBIN PUMP ALH DIMENSIONS mm (inch)

## ALHX25 - 40

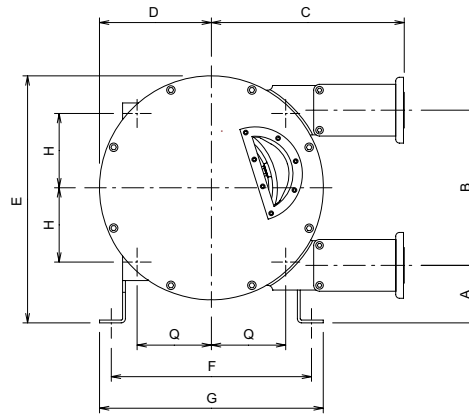
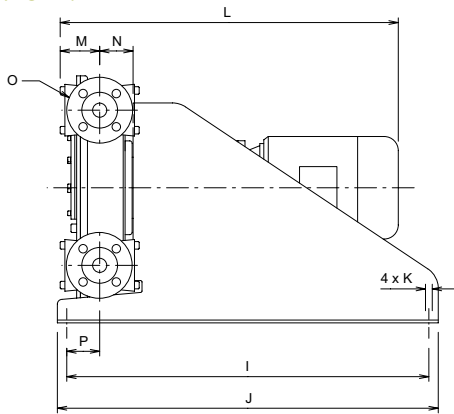

## ALHX40 - 125

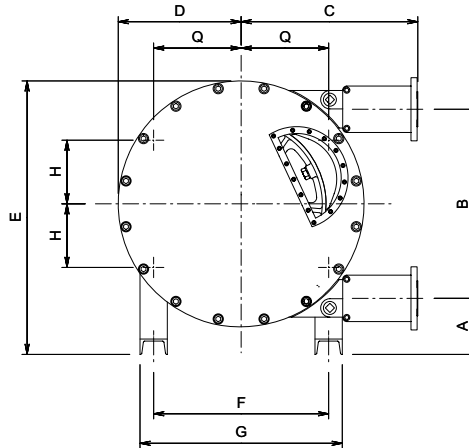
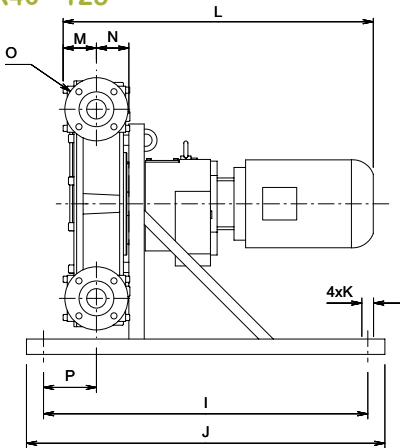

TYPE	A	B	C	D	E	F	G	H	I	J	K	L	M	N	ØO	P	Q
ALH25	95 (3.7)	262 (10.3)	356 (14.0)	134 (5.3)	430 (17)	307 (12.0)	347 (13.7)	110 (4.3)	520 (20.5)	550 (21.6)	4xø13 (4xø0.5)	-	62 (2.4)	62 (2.4)	DN25 PN16 ANSI 1 in / 150#	71 (2.8)	110 (4.3)
ALH32	121 (4.8)	330 (13.0)	438 (17.2)	237 (9.3)	524 (20.6)	424 (16.7)	474 (18.7)	158 (6.2)	770 (30.3)	800 (31.5)	4xø13 (4xø0.5)	-	85 (3.3)	75 (2.9)	DN32 PN16 ANSI 1.25 in / 150#	91.5 (3.6)	158 (6.2)
ALH40	121 (4.8)	330 (13.0)	438 (17.2)	237 (9.3)	524 (20.6)	424 (16.7)	474 (18.7)	158 (6.2)	770 (30.3)	800 (31.5)	4xø13 (4xø0.5)	-	85 (3.3)	75 (2.9)	DN40 PN16 ANSI 1.5 in / 150#	91.5 (3.6)	158 (6.2)
ALHX40	110 (4.3)	430 (16.9)	414 (16.3)	294 (11.6)	619 (24.4)	340 (13.4)	420 (16.5)	159.4 (6.3)	850 (33.5)	950 (37.4)	4xø19 (4xø0.7)	-	74 (2.9)	64 (2.5)	DN40 PN16 ANSI 1.5 in / 150#	87 (3.4)	159.4 (6.3)
ALH50	164 (6.4)	554 (21.8)	522 (20.5)	360 (14.2)	801 (31.5)	513 (20.2)	593 (23.3)	257 (10.1)	950 (37.4)	1050 (41.3)	4xø19 (4xø0.7)	-	99.5 (3.91)	87.6 (3.4)	DN50 PN16 ANSI 2 in / 150#	148 (5.8)	186.5 (7.3)
ALH65	164 (6.4)	554 (21.8)	522 (20.5)	360 (14.2)	801 (31.5)	513 (20.2)	593 (23.3)	257 (10.1)	950 (37.4)	1050 (41.3)	4xø19 (4xø0.7)	-	99.5 (3.91)	87.6 (3.4)	DN65 PN16 ANSI 2.5 in / 150#	148 (5.8)	186.5 (7.3)
ALHX65	143 (5.6)	597 (23.5)	598 (23.5)	390 (15.3)	831 (32.7)	513 (20.1)	593 (23.3)	186 (7.3)	950 (37.4)	1050 (41.3)	4xø19 (4xø0.7)	-	113 (4.4)	113 (4.4)	DN65 PN16 ANSI 2.5 in / 150#	136 (5.3)	256 (10.0)
ALHX80	158 (6.2)	746 (29.4)	609 (24)	473 (18.6)	1004 (39.5)	580 (22.8)	680 (26.8)	290 (11.4)	1150 (45.2)	1250 (49.2)	4xø19 (4xø0.7)	-	108 (4.2)	108 (4.2)	DN80 PN16 ANSI 3 in / 150#	167 (6.6)	290 (11.4)
ALH80	266 (10.5)	876 (34.5)	803 (31.6)	561 (22.0)	1265 (49.8)	690 (27.2)	830 (32.3)	345 (13.6)	1300 (51.2)	1400 (55.1)	4xø27 (4xø1.0)	-	125 (4.9)	108.5 (4.3)	DN80 PN16 ANSI 3 in / 150#	202 (7.8)	345 (13.6)
ALH100	300 (11.8)	1040 (40.9)	911 (35.9)	698 (27.5)	1516 (59.7)	820 (32.3)	960 (37.8)	387 (15.2)	1900 (74.8)	2000 (78.7)	4xø27 (4xø1.0)	-	147 (5.8)	131 (5.1)	DN100 PN16 ANSI 4 in / 150#	361 (14.2)	387 (15.2)
ALH125	285.5 (10.2)	1273 (50.1)	1037 (40.8)	818 (32.2)	1715 (67.5)	1000 (39.4)	1160 (45.7)	500 (19.7)	1900 (74.8)	2000 (78.7)	4xø27 (4xø1.0)	-	160.5 (6.3)	144.5 (5.7)	DN125 PN16 ANSI 5 in / 150#	363.5 (14.3)	500 (19.7)

Note: all pumps are available with standard motorization horizontal and on demand with vertical motorization. This offers a smaller footprint and more compact design.



## ALBIN PUMP ALH HOSES

The superior quality of Albin Pump hoses is one key to our success but, more importantly, it is the key to your success in everyday applications.

Albin Pump is constantly engaged with suppliers to provide quality hoses for superior performance in the market.

To reach that objective, Albin Pump invests in high quality raw materials (which includes natural rubber) and in an engineered hose design to perfectly balance strength and elasticity.

The result of this effort is the Albin Pump hose portfolio, which add premium performances and a life cycle up to 30% longer\* than competitive hoses.

### Albin Pump Hose Features

- ✓ Engineered design with varying inner reinforcement layers (from 2 to 6) of braided polyamide are selected based on hose material and size.
- ✓ Outer layer is vulcanized to strict tolerances to ensure perfect compression.
- ✓ Best quality raw materials create an engineered compound to combine optimum mechanical and chemical characteristics.
- ✓ External raw surface (hose is not re-machined after production) retains the lubrication film between the hose and shoe, reducing friction and heat generation to further extend hose life.
- ✓ Available in 7 different material compounds and 16 different sizes to cover a wide range of applications and pump sizes.
- ✓ Unique color code located on the hose to facilitate the material identification.

### Albin Pump Hose Competitive Advantages

- ✓ Longer life: Up to 30% longer\* than competition due to design features listed above
- ✓ Able to handle shear-sensitive fluids with minimal wear
- ✓ Highly versatile
- ✓ Available in different lengths retrofittable with most major competitive pumps (Bredel™, Verderflex™, Abaque™...).
- ✓ Once retrofitted with an Albin Pump® hose, competitive pumps reduce their TCO (Total Cost of Ownership) thanks to an extended meantime between failures.

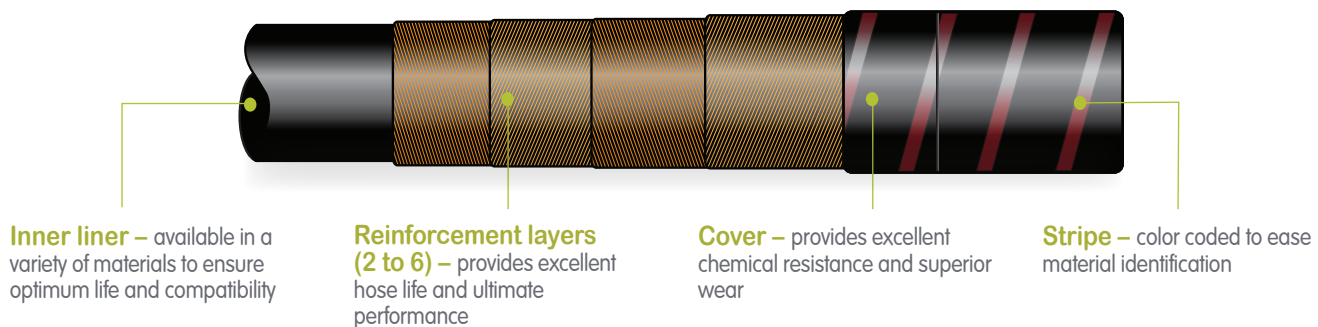

\*Relative to industry competition in comparable operating environments.

## ALBIN PUMP ALH HOSE OFFERINGS

- ✓ Available in 7 different material compounds and 16 different sizes to cover a wide range of applications and pump sizes.
- ✓ Long life material and structure with inner reinforcement layers

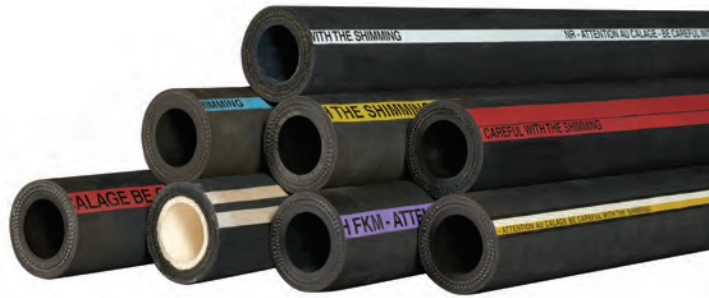

	Water Treatment, Domestic & Industrial Waste	Ceramic Industry	Mining and Quarries	Building and Construction	Chemical	Food and Beverage	Paint	Pulp & Paper	Agricultural, Biogas & Fertilizer	Min/Max Temp Range*
<b>NR</b> 	Natural Rubber (NR) can be considered a do-all material used in diverse applications; combines superior mechanical properties and provides good chemical compatibility (especially with water-based products and weak bases, acids, glycols, and ketones). Not recommended with hydrocarbons and oxidants in general.									-20°C / 80°C (-5°F / 175°F)
	✓	✓	✓	✓	✓	✓	✓	✓	✓	
<b>NBR</b> 	Nitrile Butadiene Rubber (NBR) is generally very good with natural and synthetic oils, petroleum-based fluids (non-aromatic). Mechanical properties are good, ranked behind NR.									-20°C / 80°C (-5°F / 175°F)
<b>ALH NBR - AT</b> 	✓		✓	✓	✓				✓	
<b>NBR FDA</b> 	Food Grade NBR has the same characteristics as standard NBR, but is suitable for contact with food									-20°C / 80°C (-5°F / 175°F)
	✓					✓			✓	
<b>EPDM</b> 	Ethylene Propylene Diene Monomer (EPDM) rubber has a very wide chemical compatibility for both acids and caustic applications, but is not recommended with hydrocarbons (aromatic or chlorinated) or oils (natural and synthetic). Mechanical properties are comparable to NBR.									-20°C / 90°C (-5°F / 194°F)
	✓	✓	✓	✓	✓		✓	✓	✓	
<b>HYPALON® / CSM</b> 	HYPALON®/CSM has an excellent chemical compatibility to seawater and brine, strong acids, and bases. Hypalon® is also strongly recommended with oxidants, hypochlorite, and alcohols. It is not recommended with hydrocarbons and aromatic solvents. Mechanical properties are very good just slightly less than Natural Rubber.									-20°C / 80°C (-5°F / 175°F)
	✓		✓		✓				✓	
<b>VITON® / FKM</b> 	VITON®/FKM, Viton® is a fluorinated synthetic rubber, it has the widest chemical compatibility among with the "rubber family". Can be used with strong acids and bases, aromatic solvents, hydrocarbons, and synthetic and natural oils. Viton® has a good resistance to high temperatures, but is not recommended to be used with abrasive or heavy duty applications due to its mean resistance to abrasion and average mechanical properties.									-20°C / 85°C (-5°F / 185°F)
	✓		✓		✓				✓	
<b>NR FDA</b> 	Food Grade Natural Rubber (NR) has the same characteristics as standard NR but is suitable for contact with food									-20°C / 80°C (-5°F / 175°F)
	✓					✓			✓	

\*For fluid temperatures above 40°C/104°F, consult ALH data sheets for maximum speed & pressure adjustments

## ○ ALBIN PUMP ALH CIP RANGE

### THE REVOLUTIONARY HIGH PRESSURE CLEAN IN PLACE HOSE PUMP

Albin Pump has developed a solution for easier and better clean in place hose pumps. CIP pumps are available in 4 different sizes: ALH25, ALH40, ALHX40 and ALH65. Flow rates are similar to industrial ALH pump range.

#### HOW DOES IT WORK?

Albin Pump has developed a specific and a unique wheel to meet the requirements of its industrial customers from food, cosmetic and pharmaceutical industries.

The new ALH CIP pump has a patent pending designed pump-wheel that will allow the pressing shoes to retract (not to compress the pump) for an efficient clean in place process. Albin Pump offers the option in the range of peristaltic ALH pumps. It allows users, by simply reversing the direction of rotation of the pump (½ turn), to be able to retract the shoes automatically, in order to make the cleaning and sterilization operations, without any action on the pump.

#### SAVE TIME AND GET THE BEST TOTAL COST OF OWNERSHIP

The client saves time and will keep the highest level of functionality in the process. The design is done with a minimum use of moving parts and requires a minimum amount of maintenance, all to guarantee a maximum amount of function and production time. The new CIP wheel in combination with Albin Pump world leading design and exceptional long hose lifetime creates even more effective production processes.

The advantage of this technology is that it does not damage or shear the pumped fluid while maintaining a high level of hygiene. Only the inner part of the hose NR FDA or NBR FDA is in contact with the pumped fluid.

The Albin Pump Peristaltic pumps are used for the transfer of all type of fluids:

- ✓ Viscous
- ✓ Abrasive
- ✓ Corrosive
- ✓ Fibrous with particles

#### HOSE MATERIALS

Albin Pump can offer food grade hoses in NR FDA and NBR FDA and meet the certifications EC 1935/2004 and FDA CFR21§177.2600. The internal layer of the hose is white (NR FDA) or black (NBR FDA), according to the pumped fluid.

The "CIP wheel" is available on several models: for flows from 0.5 up to 10 m<sup>3</sup>/h (1,4 gpm-45 gpm) and where the maximum discharge pressure can reach 15 bar (220 psi).

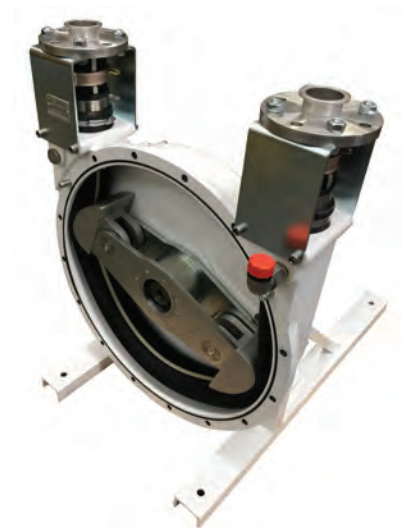
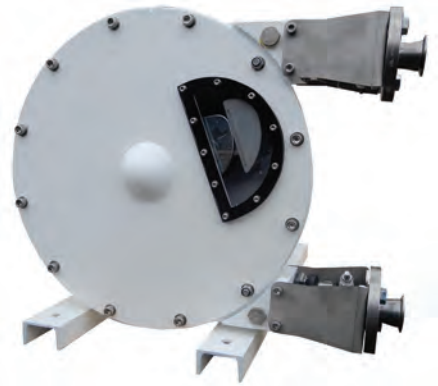

## ALBIN PUMP ALHS SERIE

### BARE SHAFT PUMP

For customers who require a long shaft technology, Albin Pump has also developed the ALHS series.

These pumps are equipped with a removable bearing case for easy bearing maintenance and can be converted into a close coupling ALH type pump at any time. In addition this solution allow customer to take advantages of Albin pump products by retrofitting existing installations using same technology form competitors.

### ALHS DUPLEX WITH TWIN PUMP HEADS

Albin Pump designs and manufactures duplex models featuring twin pump heads. With this duplex system, flow rates range from 0 to 125 m<sup>3</sup>/h (634 gpm) for the duplex ALHS125D.

All ALH pumps starting from size 25 are available in duplex configuration. Duplex pump is identified with the following nomenclature: ALHSXXXD.



*Bare Shaft Pump*

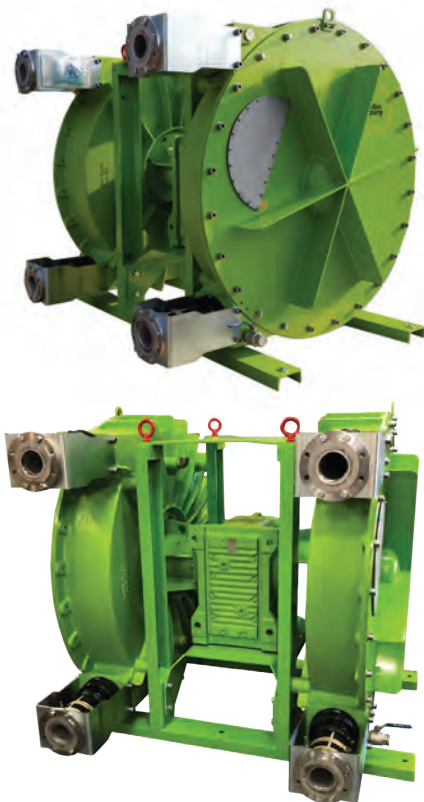

*ALHS125 Duplex pumps*



*ALHS80 Duplex for quarries*



## ALBIN PUMP ALH OPTIONS AND ACCESSORIES

### ALHP PULSATION DAMPENERS

The ALBIN Pump ALHP in-line pulsation dampener will reduce vibration and water hammer in your piping therefore increasing the hose life.

This is achieved by means of a thick-walled, reinforced rubber hose which is mounted in a carbon steel, cylindrical pressure vessel. The hose is surrounded by compressed air (nitrogen when ATEX equipped). Pulsation is created by the peristaltic pump functioning principal, whereas the rubber hose in the pulsation dampener adapts its volume to compensate pulsation and provide a smooth flow to the discharge line.

The ALBIN Pump ALHP in-line pulsation dampener can cut up to 90% of the pulsation created by the pump.

ALHP Pulsation dampeners are available in 4 sizes to cover ALH pumps from ALH25 to ALH125.



ALHP125 for biogas

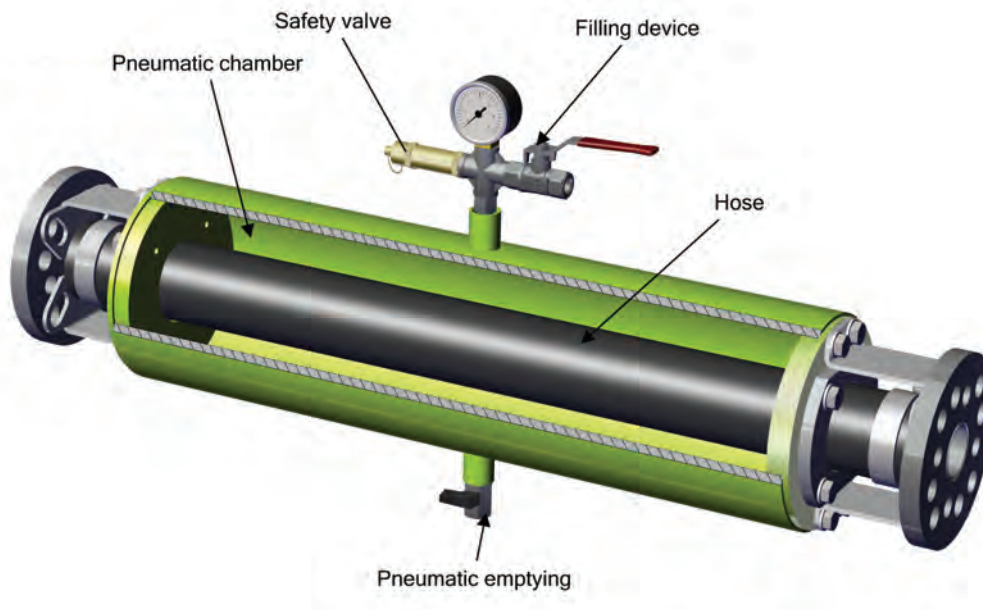

ALHP model	Standard Connections	For pump
ALHP040	Multiple holes flange DIN or ANSI (PN16,150#)	ALH025-ALH032-ALH040-ALHX40
ALHP050	Multiple holes flange DIN or ANSI (PN16,150#)	ALH050-ALH065-ALHX65
ALHP100	Multiple holes flange DIN or ANSI (PN16,150#)	ALHX80-ALH080-ALH100
ALHP125	Flange DIN DN125/PN16 or ANSI 5"/150#	ALH125

# ALBIN PUMP ALH OPTIONS AND ACCESSORIES

## OTHER OPTIONS

- ✓ Different connections such as JIS, SMS, Tri-Clamp, DIN11851 and more
- ✓ Variable Frequency Drive, all our pumps are delivered ready to be connected to a VFD. Please contact your regional customer support team for built-in VFD options and availabilities
- ✓ Mobile trolley
- ✓ Hose rupture detector and revolution counter
- ✓ Pneumatic vacuum system
- ✓ ATEX II & I certification
- ✓ Special accessories and configurations on demand



Pneumatic vacuum system



Hose rupture detector



ALH with cooling cover



ALH25 pumps stacked, used for the distribution of lime milk in a municipal water treatment plant

## RELATED ALBIN PUMP RANGES

Discover our ALP Low Pressure Tube Pump range with a flow up to 10 m<sup>3</sup>/h (45 gpm) and a maximum pressure of 4 bar (60 psi).



SCAN TO  
LEARN  
MORE  
ABOUT  
ALBIN  
PUMP





# Overview of Albin Pump ALH Applications

## HOSE PUMP APPLICATIONS

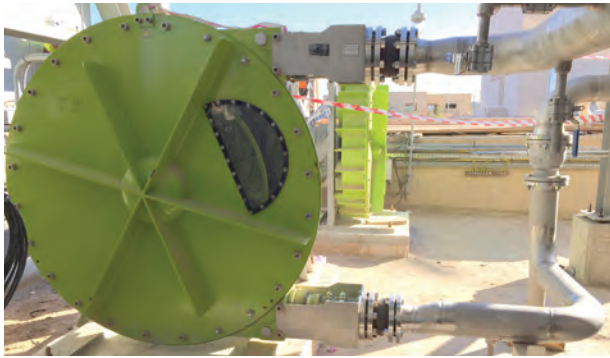

ALH125 pumping concrete

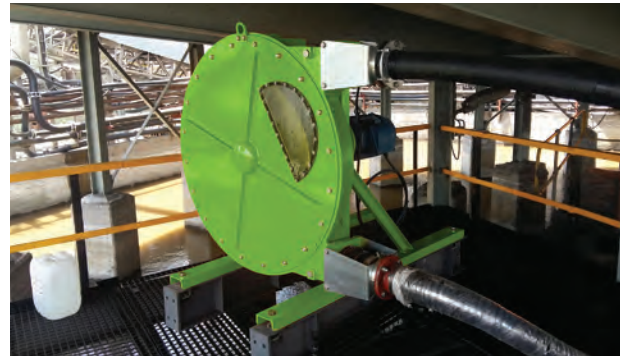

ALH100 for thickener underflow in mining industry

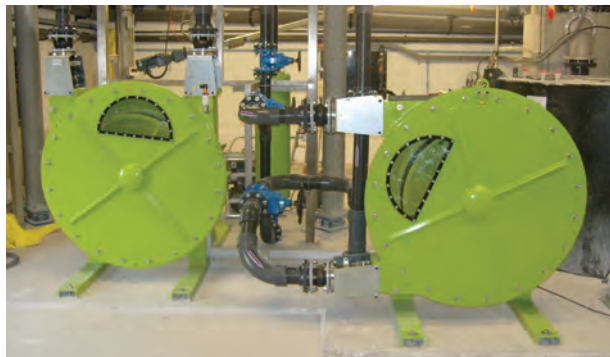

ALH100 handling limewater in a wastewater treatment plant



ALH100 pumping thickener underflow in a quarry



ALH125 for biogas applications



ALH125 for car battery recycling, handling wastewater and slurries



ALH125 for truck unload of fertilizer in agriculture



ALHX40 for lime milk in wastewater treatment

Distributed by:

[www.albinpump.com](http://www.albinpump.com)

[albinpump@irco.com](mailto:albinpump@irco.com)



### About Ingersoll Rand Inc.

Albin Pump is a brand of Ingersoll Rand and part of the Precision and Science Technologies (PST) business segment. PST consists of a portfolio of complementary, mission critical brands such as Milton Roy®, ARO®, LMI®, Albin Pump, Thomas®, Welch®, Haskel®, Dosatron®, YZ®, Williams®, SEEPEX®, MP® and Oberdorfer®.

At PST, we deliver solutions for precision dosing and transfer of high value fluids in various markets such as medical, food and beverage, water and hydrogen. For more information, visit [www.IRCO.com](http://www.IRCO.com).

We are committed to using environmentally conscious print practices

©2022 Ingersoll Rand  
IRITS-0322-010 EN